



KRONE

BiG X

480 · 530 · 580 · 630

Forage harvesters



BiG X

480 · 530 · 580 · 630

Forage harvesters

- 490-653 hp continuous engine output
- 6 intake rollers for premium safety and a top quality chop
- **MaxFlow** chopping drums with 20, 28 or 36 blades, biogas drum with 40 blades
- KRONE **VariQuick** for ultra-quick changeover with or without grain conditioner
- **OptiMaxx** roller conditioners measuring 250 mm in diameter and 570 mm in width for intensive kernel processing



- KRONE **VariLOC** for flexible choice of long and short chops
- KRONE VariStream – spring-loaded plates beneath the chopping drum and at the crop accelerator ensure a continuous crop flow
- Convenient hoop coupler for easy attachment to the base machine
- Superb manoeuvrability from independent wheel suspension and wheel motors
- Optionally with four-wheel drive
- 3 m machine width (depending on tyres) for easy travel on public roads



BiG X 480, 530, 580 and 630 – the compact precision forage harvesters from KRONE for outputs of 490 hp to 653 hp and maximum chopping quality and output as well as superior ease of use and operator comfort.

KRONE OptiMaize	4
The crop flow	8
The intake system	10
The chopper unit	12
The biogas drums	16
VariLOC	18
The roller conditioners	20
VariQuick	22
VariStream	24
StreamControl	26
The headers	28
EasyFlow	30
XDisc	34
EasyCollect	38
XCollect	42
The engine	46
The drive concept	48
The running gear	50
The comfort	54
The cabin	56
Operator Assist Systems	58
Technical data	62



KRONE OptiMaize

- KRONE chopping technology for optimum maize forage quality
- **OptiMaize S, M, L, XL** for variable chopping lengths from 4 mm to 30 mm
- KRONE **MaxFlow** and biogas chopping drums with different numbers of blades for producing the cutting length you need
- KRONE grain conditioners ensure optimum fracturing and kernel treatment
- KRONE **VariLOC** for flexible long and short chops without converting the machine

OptiMaize brings full flexibility to all KRONE BiG X forage harvesters, allowing them to produce any type of cutting length forage producers call for. MaxFlow and Biogas drums are available with various numbers of blades and combine with the specific KRONE conditioners for chop lengths of 4 mm to 30 mm.

‘OptiMaizing’ – a KRONE concept for BiG X forage harvesters

The OptiMaize concept was developed by KRONE and aims at producing forage of a superior quality. Livestock farmers ask for different chop lengths that meet different aims in the silage maize ration. The smaller the amount of fibres in the ration, the longer should the maize chops be to suit the needs of ruminants.

By comparison, chop lengths should be short when the maize is used to fuel Biogas plants whereas the feed rations for beef bulls and dairy cows require much longer chop lengths to add structure to the ration. KRONE OptiMaize combines various chopping drums (see table) and conditioners that enable BiG X forage harvesters to produce short and long chops of maize allowing machine owners to respond to individual customer needs. If you have to produce short biogas maize chops in the morning but coarse maize chops for animal feed in the afternoon, you will find KRONE VariLOC the ideal solution for you. This is a mechanical gearbox

which forms an integral part of the pulley that drives the drum belt; it reduces the drum speed from 1250 rpm to 800 rpm within just a few minutes. This reduces the cutting frequency and increases the range of available chop lengths by up to 50%. This technology allows operators to select between short and long chops at short notice and without any drum changeovers. This in combination with the large choice of KRONE conditioners makes BiG X a truly all-round machine.

In practical application, the chop lengths can be grouped into four different ranges: OptiMaize S, M, L, and XL. Each concept describes a different technical solution that leads to customised lengths that suit all applications.



OptiMaize

OptiMaize S	4 mm – 7 mm	Biogas	Biogas (40 blades) or MaxFlow (36 blades)
OptiMaize M	8 mm – 10 mm	Dairy feed rations with ~40% maize; beef bulls	MaxFlow (36 blades) or MaxFlow (28 blades)
OptiMaize L	11 mm to 19 mm	Dairy feed rations with ~60% maize	MaxFlow (28 blades) or MaxFlow (20 blades)
OptiMaize XL	20 mm – 30 mm	Dairy feed rations with >80 % maize	MaxFlow (20 blades)



The proper density

With cutting lengths of more than 20 mm, compaction takes significantly more effort. Clamping forage that is chopped to lengths longer than 20 mm requires more time and heavier equipment to eliminate the risk of mould and heating.



KRONE OptiMaize



OptiMaize S

Maize that is harvested to fuel biogas plants is chopped to very short lengths. Depending on moisture levels, chops of 4 mm to 7 mm lengths have been found ideal for this application because shorter chops make the energy readily available to the methane producing bacteria in the fermenter thereby increasing gas yields.

The KRONE forage harvesters use a biogas drum with 40 or 48 blades to harvest biogas maize. Alternatively, OptiMaize S results can also be achieved with the 36-blade MaxFlow drum. For good fermentation, the leaves and stalks are subsequently fractured and the kernels destroyed by a KRONE OptiMaxx corn conditioner with 123/144 teeth and rotors rotating at a 30% speed difference.



OptiMaize M

Chop lengths between 8 and 10 mm are suitable for beef bulls and for dairy farming with grass-based feeding consisting of up to 40% maize. This cutting length and the appropriate conditioning of the chopped material helps to avoid a lack of structure in the forage. OptiMaize M chopping quality is achieved by the MaxFlow chopping drums with 36 and 28 blades. The ideal conditioner is the KRONE OptiMaxx conditioner with 123/144 teeth whose speed differential can be increased from 30% to 40% or 50%.



OptiMaize L

Chop lengths of 11 mm to 19 mm are ideal for dairy feed rations where the percentage of maize is about 60%. Ruminants require silage maize that is rich in fibre.

The OptiMaize L chopping quality is achieved by the KRONE MaxFlow drums with 28 or 20 blades. The complementary conditioner for these drums is the KRONE OptiMaxx with 105/123 teeth. The speed differential on these rollers can be increased from 30% to 40% or 50%.



OptiMaize XL

The maize in dairy feed rations made up of more than 80% by maize without sufficient quantities of grass and feed straw should be chopped to 20 mm to 30 mm lengths to avoid lack of structure in the forage. The ideal drum for long chops is the MaxFlow drum with 20 blades which is complemented by the KRONE OptiMaxx corn conditioner with 105/123 teeth and 30%, 40% or 50% speed differentials.



The crop flow

- Six intake rollers ensure a top-notch quality of chops
- High throughput with universal or biogas drums
- **OptiMaxx roller conditioner:** Intensive conditioning
- **VariStream:** Continuous crop flow
- **StreamControl:** Adjustable discharge distance as an option
- **VariQuick:** Quick changeovers between corn and grass

If the priority is on the highest throughput, premium technology is required. With the BiG X, KRONE offers a forage harvester which convinces by top cutting quality, highest throughput and maximum user comfort thanks to the direct crop flow and the numerous innovative details which meet the requirements of successful service providers and make the working day easier.

Chopping drum

- Universal MaxFlow chopping drum with 20, 28 or 36 blades
- 40-blade Biogas drum

The suitable drum for top quality chop

Intake system

- 6 intake rollers
- Additional protection against foreign objects
- Hydraulic drive
- Steplessly variable LOC

Perfectly protected to achieve the optimum chop length

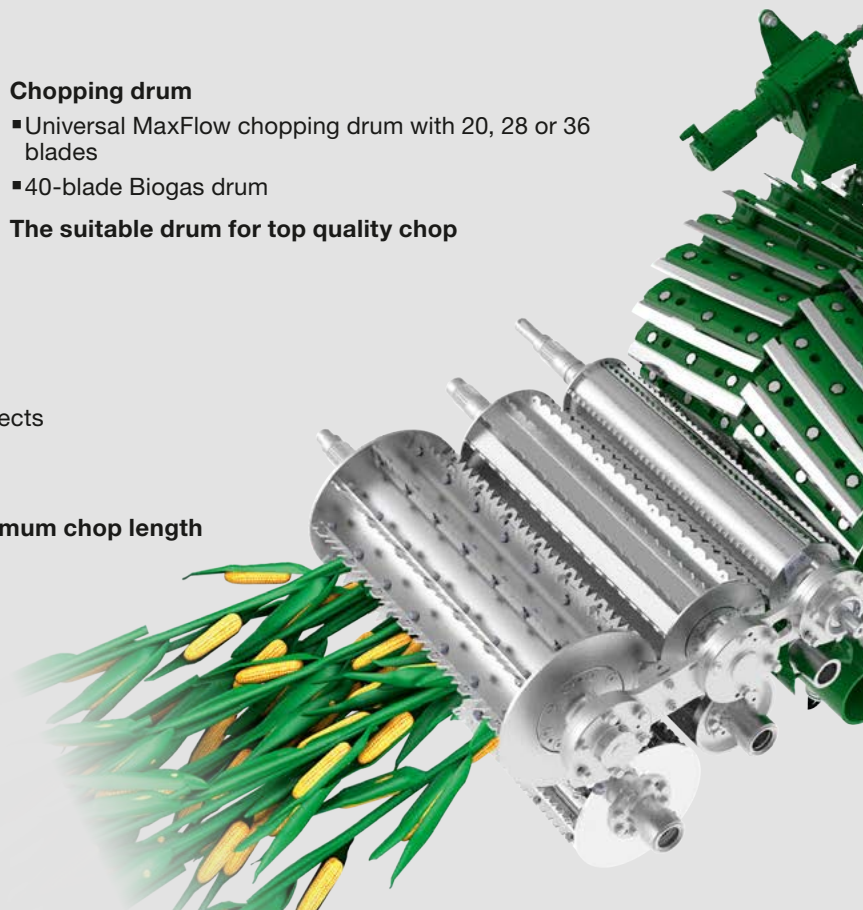



StreamControl

- Powerful crop accelerator
- Adjustable crop throw
- Precision fills of trailers following behind
- Highly fuel-efficient

- No losses

VariQuick

- Minimum changeover between grass and corn/maize
- Quick changeovers between corn conditioning and harvesting grass
- Removing the corn conditioner is convenient using a lowering mechanism

Quick changeovers

The OptiMaxx roller conditioners

- 250 mm diameter and 570 mm wide rollers for maximum performance
- Slanted teeth give a unique shearing effect for perfect cracking
- Up to 50% speed difference for optimum fracturing results

Perfect conditioning

VariStream

- Spring-loaded floor underneath the chopping drum
- Spring-loaded accelerator backplate
- Continuous crop flow

High throughputs



The intake system

- 6 pre-compression rollers for top-quality chops
- Hydraulic drive:
LOC is steplessly adjustable from the cab
Automatic adjustment via AutoScan
- Maximum protection against foreign objects:
Long path from metal detector to chopping drum
Metal detection across the entire chamber width

On a BiG X, it is also the intake system that has an influence on the quality of chop. The six intake rollers compress the chopping crops consistently at a high pressure so that it is easier and more precisely to chop. The hydraulic drive of the intake system allows operators to choose between setting the cutting length manually or automatically.

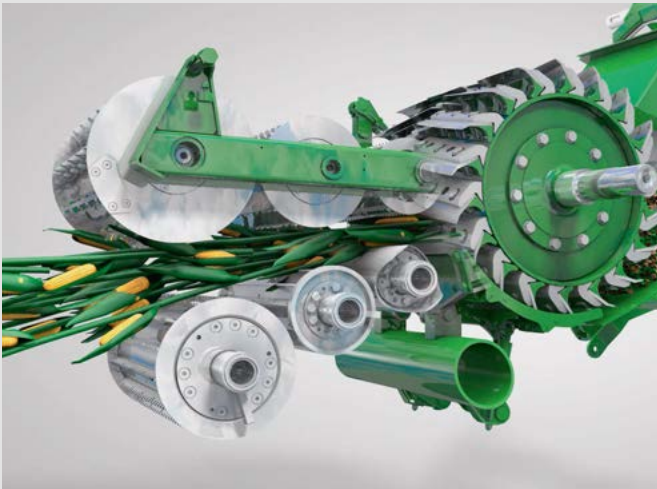

Continuous, safe, and comfortable

Six pre-compression rollers and 820 mm distance between the front roller with metal detector and the rearmost roller provide for improved pre-pressing and added protection from metal foreign object during fast intake. The hydraulic driveshaft automatically adjusts the LOC in line with the maturity of the crop, which is detected by the KRONE AutoScan sensor. If the engine speed falls below 1,200 rpm with increasing load, the intake and header are stopped automatically while the chopping drum is running. This prevents crop blockages due to excessively slow rotational speeds, and thus saves time and money.



Carefully designed

For quick access to the chopper unit, the intake on wheels can be switched off.



Full-width application

Metal detection sensors covering the full width are installed in the front lower intake roller. They ensure full-width detection of metal carried into the unit.



Convenient

The intake system can be folded forwards for easy inspection access to the chopping drum and counterblade.

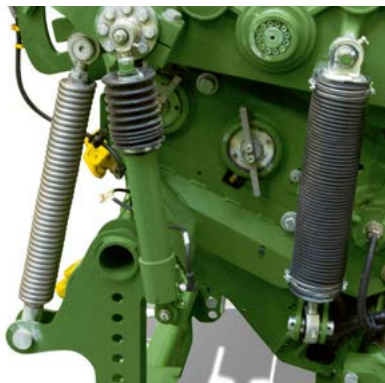

Under pressure

Adjustable coil springs keep up the pressure on the crop from the intake rollers, ensuring strong crop compaction and top chopping results.



Large aperture for high throughput

The huge aperture between the six intake rollers allows for premium flowthrough volumes. The robust drives for the pre-compression rollers are designed for heavy-duty use.



The chopper unit

- Chopping drums with 20, 28, 36 or 40-blades for OptiMaize S to XL
- High inertia: enclosed 660 mm diameter drums
- Bespoke 630 mm wide drums for the BiG X 480, 530, 580 and 630 models
- Extremely fuel-efficient courtesy of a high inertia and pulling cuts

Matching the drum dimensions to the harvester model and choosing the optimum number and shape of blades not only boosts the power of the BiG X but also makes the OptiMaize S, M, L, and XL more flexible to suit more applications. The wide range of drums available for BiG X deliver a top-quality chop in any conditions anywhere in the world – at top performance levels.

Optimum layer thickness

It's not just the number of blades that accounts for a good quality chop. The thickness of the mat that passes through them and therefore the width of the chopping drums are just as important. Therefore KRONE designed a wider 630 mm chopping drum for the BiG X 480, 530, 580 and 630 which carries the customary high chopping quality of the high-capacity foragers with 800 mm drums over to the smaller models.



Drum type	MaxFlow	MaxFlow	MaxFlow	Biogas
Number of blades	20	28	36	40
LOC	5 - 31 mm	4 - 22 mm	3 - 17 mm	2.5 - 15 mm



The material is pulled over the blades

The blades on the KRONE chopping drums are arranged chevron-style and at an angle of 11° relative to the counter-blade. This arrangement makes for a continuous crop flow, extremely quiet running and maximum efficiency.



Kitted out to purpose

The BiG X can be fitted with grass or maize blades. Oblong holes on the blades allow for precision adjustment relative to the counterblade and protect the blades against breakage when they hit foreign objects.



The KRONE MaxFlow chopping drums

- For grass, wilted crops, whole crop silage and maize in **OptiMaize S, M, L, XL**
- Chopping drums with 20, 28, or 36 blades
- Plenty of carrying space under the blade carriers
- Blades are quick and easy to insert and remove

The MaxFlow chopping drums are specially designed for conditioning of high-quality silage. Harvesting wilted crops with unevenly formed swaths is a challenge for the chopping drum; therefore, its blade supports have a special shape which leaves more room under the blades. Larger 'pockets' and the spring-loaded drum floor result in extremely smooth running and high power reserves. So BiG X makes light work of temporary crop accumulations.

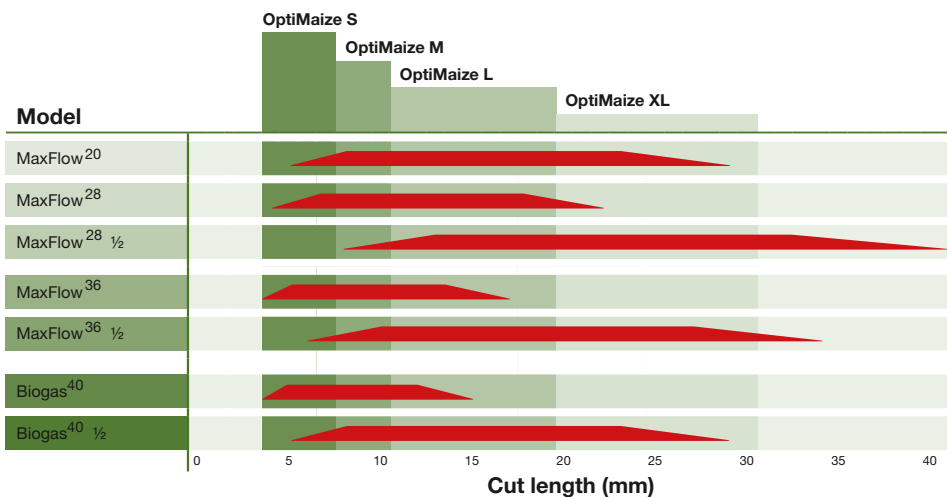

Always the proper length

The KRONE OptiMaize chopping drum offers a wide range of technical solutions that achieve an equally wide range of chop lengths. With a full or half set of blades, the KRONE chopping drums allow users perfect adjustment of the chop lengths to the respective application.



Quick blade installation

Each blade is screwed to the chopping drum with three hexagon head screws only. The blades are also held by the blade support of the drum arranged above the blades.



Cutting edge

To ensure a good quality cut, the blade and the counterblade must be set to the correct gap. The blades are quick and easy to align using the eccentric plate.



Room for conveying

The blade carriers are arranged and designed to allow plenty of space under the blades. More room for conveying crops means higher flowthrough volume and quieter running, particularly with large cutting lengths.



OptiMaize M, S

36 blades

With a high flowthrough volume in a wide range of cutting lengths, the 36-blade chopping drum pays for itself very quickly. With half a set of blades, it is perfectly suited for use with larger cutting lengths.

LOC range: 36 blades: 3 - 17 mm
18 blades: 6 - 34 mm



OptiMaize L, M

28 blades

The 28-blade chopping drum is fit for universal application; with half a set of blades, it is perfectly suited for use with larger cutting lengths.

LOC range: 28 blades: 4 - 22 mm
14 blades: 8 - 42 mm



OptiMaize XL

20 blades

This drum cuts the kind of long lengths that are called for in some countries.

Cutting length range: 20 blades: 5-29 mm



The KRONE biogas drum

- 40 blades arranged in V-shape
- High frequency of cuts
- High productivity
- **OptiMaize S**
- High gas yields

With its 40 blades, the KRONE biogas drum chops the crops very thoroughly. OptiMaize S achieves very short chop lengths which enable high throughputs both on the machine and in the fermenter, making BiG X a major factor in biogas plant productivity.



40 blades

With its higher throughputs and lower fuel consumption per tonne of chopped maize, the 40-blade Biogas cylinder pays for itself in no time. With a theoretical cutting length of 2.5 to 15 mm, the short chopping crops increase the efficiency in the fermenter of a biogas unit. Thanks to the improved gas yield per m³ of chopped material, the cultivation area for biogas can be reduced.



High frequency of cuts

40 blades can achieve an impressively high cutting frequency. So the biogas drum cuts harvesting time and increases throughput – even when producing short chop lengths.



Standard drum compared to biogas drum

Cutting length: 5 mm

Consumption (l/t fresh mass)

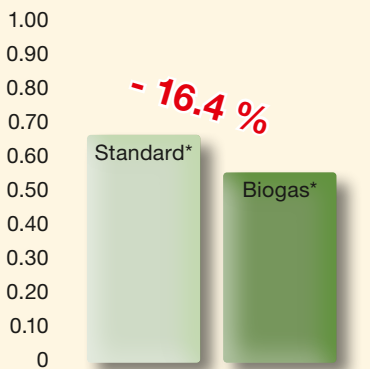

Throughput (t fresh mass/h)

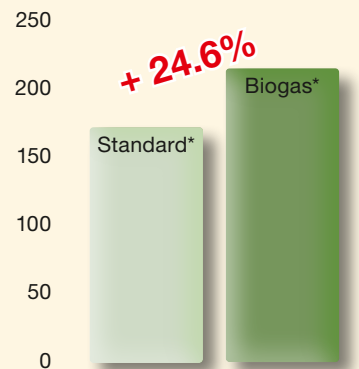

*Standard = 28 blades

*Biogas = 40 blades

OptiMaize



Higher efficiency, lower costs

With short chop lengths, the 40-blade KRONE biogas drum increases the throughput by almost 25% compared to the 28-blade MaxFlow chopping drum. The fuel consumption per ton of chopped crops is reduced by up to approx. 16%.*

* Results from the 2006 workshop with leading agricultural magazines



KRONE VariLOC

- Optimaize is a versatile and unique system
- Cutting length gearbox for flexible use in short and long cut applications
- Changeover of the drum speed is a matter of a few minutes
- No machine conversion, no up-front planning

VariLOC is a gearbox in the pulley of the chopping drum. By simply changing the drum speed from 1250 to 800 rpm using a standard open-end wrench, you can increase the chopping drum's LOC range by up to 50%. This makes a quick changeover between long or short chops possible. You can fulfil your customers' fluctuating demands without any conversion or up-front planning. Combined with the new 105/123 tooth roller conditioner (with 30%, 40% or 50% speed difference), this gearbox turns your BiG X into an all-rounder and gives you maximum flexibility.

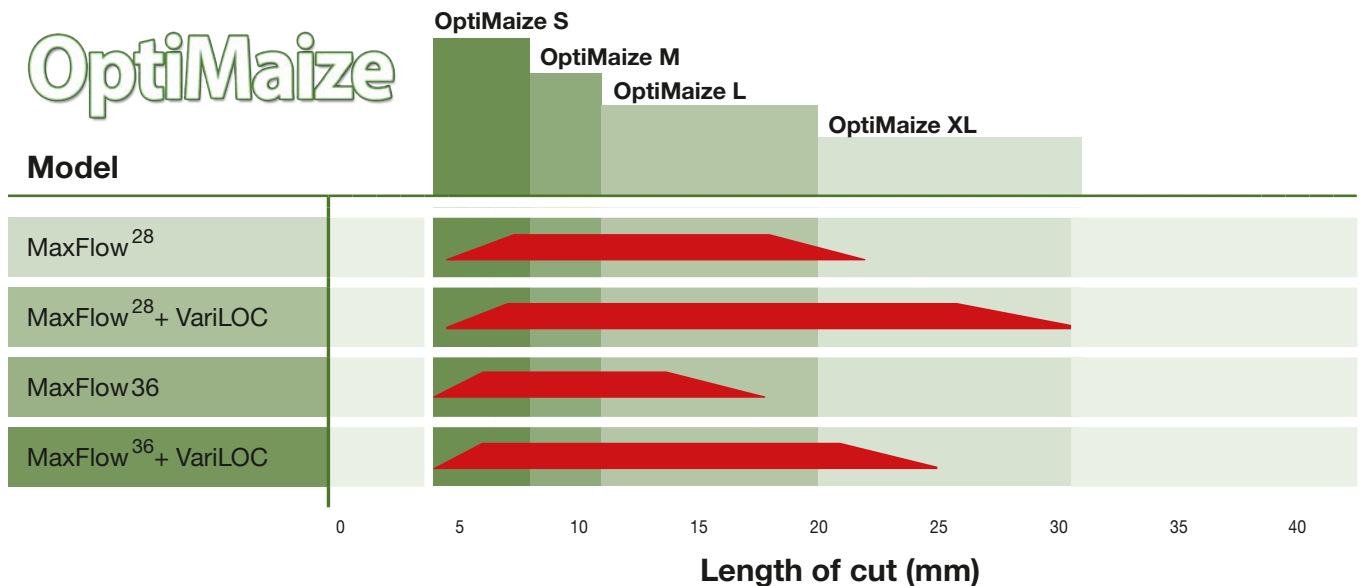

Great flexibility

The KRONE VariLOC is available for the KRONE MaxFlow drums with 28 and 36 blades. VariLOC is a mechanical gearbox that allows the MaxFlow chopping drum to produce the full range of chop lengths (OptiMaize S-XL) with 28 or 36 blades.



Chop length ranges offered by VariLOC

Chopping drum	min. LOC [mm]	max. LOC [mm]	LOC range [mm]	Expanding the LOC range
MaxFlow 28	4	22	18	
MaxFlow 28 with VariLOC	4	30	26	+ 45 %
MaxFlow 36	3	17	14	
MaxFlow 36 with VariLOC	3	24	21	+ 50%

Wide cutting range

The KRONE VariLOC increases the cutting lengths that are available from the MaxFlow chopping drums with 28 and 36 blades.

For the 36-blade drum, it increases the range by 50% from 3-17 mm to 3-24 mm. For the 28-blade drum it increases the range by 45%, which means from 4-22 mm to 4-30 mm. This allows operators to adjust the chop length flexibly as the application changes.

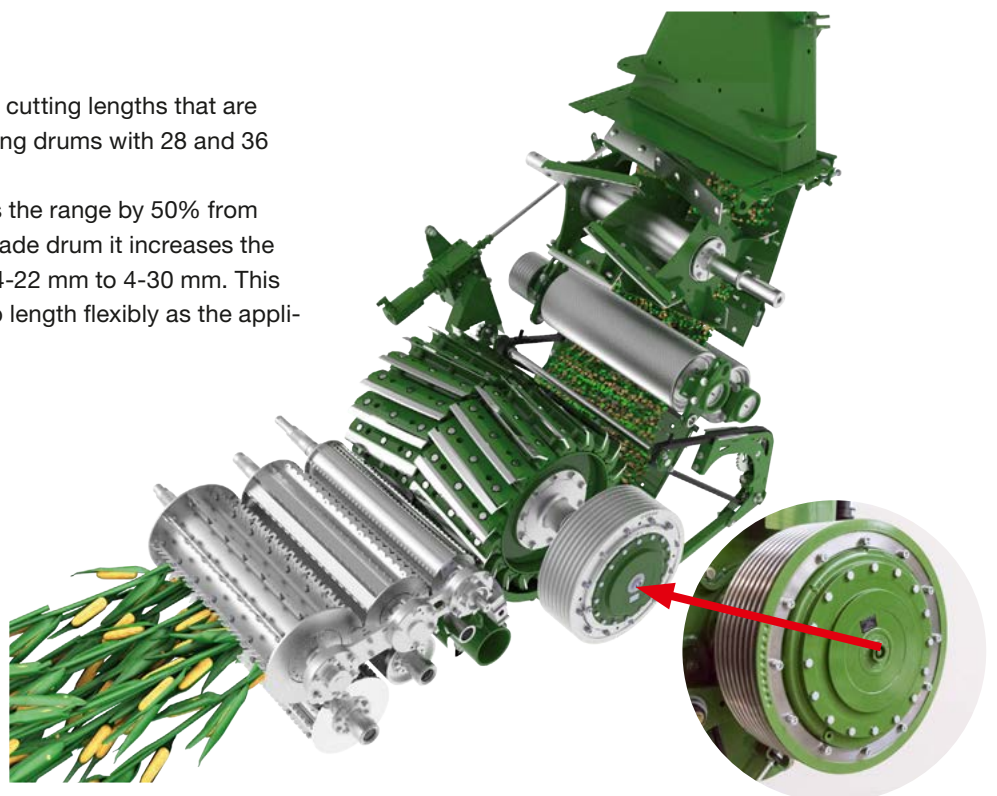



The KRONE OptiMAXX roller conditioners

Our roller conditioners redesigned

- 570 mm wide and 250 mm diameter **OptiMaxx** roller conditioners
- Slanted teeth for perfect conditioning to combine with **OptiMaize S-XL** drums
- **BusaCLAD** -Special coating technology for maximum service life
- The gap between the rollers is conveniently adjusted from the cab
- A strong spring assembly provides a consistent and high pressure
- Maximum fracturing from an up to 50% speed difference (option)

Every single kernel must be cracked to achieve an optimal digestibility.

These user demands are perfectly met by the new OptiMaxx roller conditioners with their slanted teeth, a new KRONE development. The rollers score on a massive 250 mm diameter and a 570 mm width



Perfect conditioning

The new OptiMaxx roller conditioners have their teeth slanted at a 5° angle. This slant produces a clearly higher shearing effect and perfect conditioning of the crop which receives a very intensive treatment both length- and sideways.

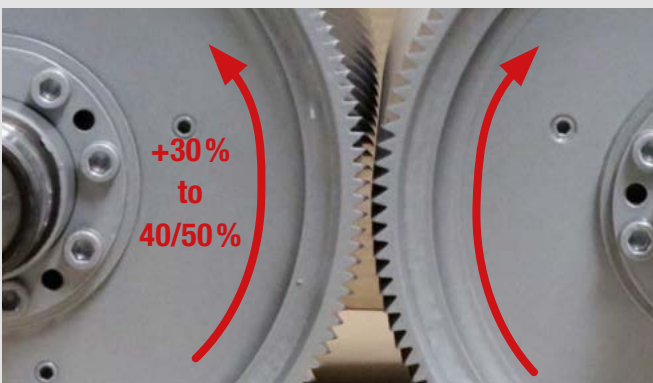

Maximum intensity

The two toothed rollers operate at a 30% speed difference. This standard difference can now increase to 40-50% to deliver 100% conditioning and fracturing of long chops as produced by OptiMaize XL.



Variable roller gap

The operator can control the roller distance from the cabin, adjusting it infinitely to the current conditions. The current setting is shown on the display screen.



The top-standard **OptiMaxx 250**

With the new OptiMaxx 250, KRONE presents a roller conditioner that offers an even higher performance for the BiG X 480, 530, 580, 630 models. This new development stands out for the following features:



- **250 mm diameter** rollers have slanted teeth that give a unique shearing effect
- The two rollers in the assembly have different numbers of teeth:
 - 105/123 for medium and long chopping lengths
 - 123/144 for short and medium chopping lengths
- **A standard 30% speed difference with a 40% or 50% differential being an option** for intensive fracturing and optimum cracking results
- **HD rollers** are available as an option, featuring the innovative **BusaCLAD coating technology**
 - Best protection from wear and longest service life in all harvest conditions.

OptiMaize

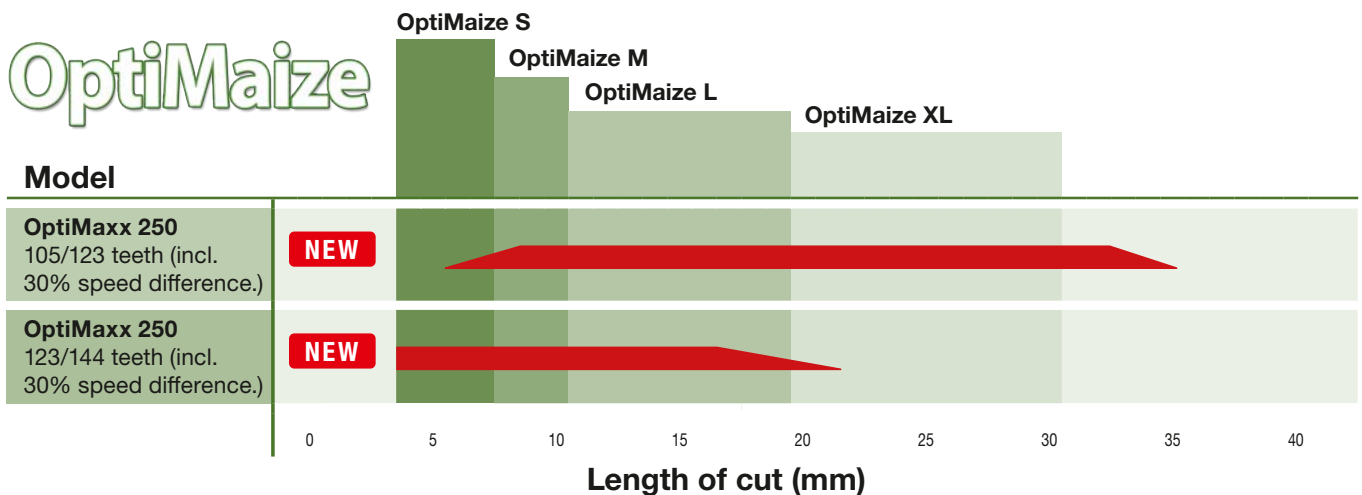



KRONE VariQuick

- Fast changeovers from grass to corn conditioning and vice versa
- A chain drive lowers the unit conveniently
- The changeover takes just a few minutes
- Fast and easy removal of the grain conditioner

VariQuick is the system that allows operators to converse BiG X very quickly from maize to grass and the other way round. A chain drive (electric option) moves the corn conditioner out of or into the crop flow. If the corn conditioner is not used for longer periods of time, you can lower it and remove it from the machine by pulling it out to the side.



Quick changeover

Change from maize to grass or from whole crop silage to grass on the move – either using a chain drive with crank handle or an electric motor as an option. This allows BiG X to change from maize to grass or from whole crop silage to grass flexibility and quickly.



Easy to transport

After the transport wheels are fitted without tools, the corn conditioner pulls out to the side and is conveniently rolled to the shed.



Using the grain conditioner

In this position, the crop flows through the corn conditioner. This way, the conditioner can subject the kernels to intensive treatment to make the nutrients available.



Corn Conditioner in park position

The chain drive moves the corn conditioner out of the crop flow and into its parking position so work can temporarily continue in grass without any major changeover.

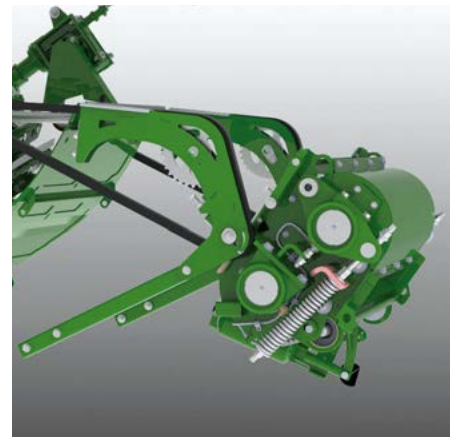

Removing the Corn conditioner

If the corn conditioner is not used for an extended period of time, you can lower it with the help of the chain drive and then remove it.



KRONE VariStream

- Consistently smooth performance despite inconsistent crop flows
- Extremely smooth running – also in lumpy swaths
- High throughputs
- Top quality chop
- Perfect operator comfort

VariStream comprises spring-loaded floors beneath the chopping drum and behind the discharge accelerator rotor. The system ensures blockage-free and smooth operation, even in varying volumes of crop. The technology allows operators to utilise the forager to its limit and use less fuel per hour.



Springs make the difference

Every forage harvester operator is familiar with this: Lumps in uneven swaths absorb operator attention, reduce productivity and may cause blockages in the spout. The chopping drum floor and the rear wall of discharge accelerator are both spring-loaded to momentarily extend the crop flow channel when the volume surges temporarily. The flexible channel cross-section helps to relieve the engine and the chopper units and makes for quieter running and higher outputs.

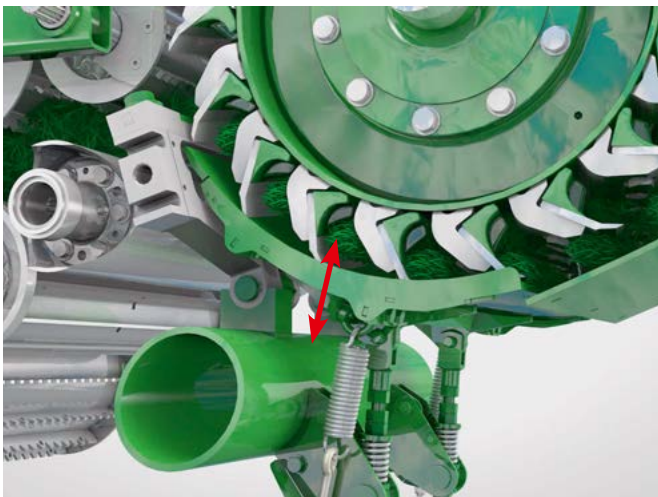

Top quality chop also with uneven volumes of crop

The spring-loaded chopping drum floor is connected to the anvil of the counterblade at the front. As these are readjusted, the gap between the blades and floor does not change. So any movement of the spring-loaded drum base in compensation of bigger crop lumps will not affect the quality of chop.

Constant discharge with a concentrated stream

The spring-loaded rear wall of discharge accelerator ensures maximum discharge capacity and fills the transport wagon dead on target in all conditions.



KRONE StreamControl

- An adjustable discharge distance at the touch of a button from the cab
- Tight crop stream even with a long crop discharge
- The shorter the crop discharge, the less power is needed
- Fills the trailer accurately without spillage

The crop throw is controlled from the cab by adjusting the door in the backplate on the crop accelerator. This way, operators can adjust the throw quickly to the current filling situation. As the accelerator needs less power to cover a short distance, the operator can free up engine output and use it for chopping and higher throughputs.



Short-distance discharge

For a small discharge distance and trailers driving in parallel, it is of advantage when the crop stream is ejected at slow speed. The "weaker" stream frees up power reserves that can be used for an increased chopping performance.



Long-distance discharge

With the trailer following behind, the crop stream needs to be ejected from the spout at a higher speed. A strong, tight stream is needed to cover the long distance over the tractor to the rear wall of the trailer.

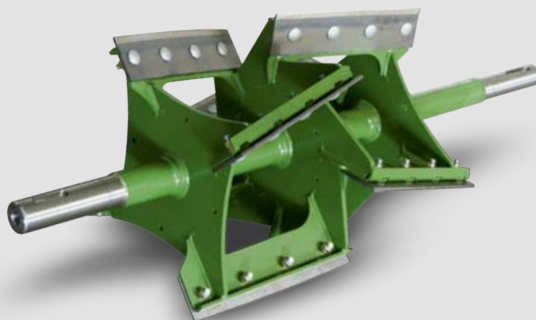

Crop accelerator

The discharge scoops are designed for a high discharge capacity and guide the crop flow towards the middle.



Adjusting the discharge distance

The crop discharge is controlled via the hinged flap on the rear wall of discharge accelerator. For a short-distance discharge, the flap moves out of the crop flow, so there is little contact between the crop and the accelerator. For a long-distance discharge, the flap moves into the crop flow, so there is more contact between the crop and the accelerator.



Via control lever

The throw is quickly changed on the joystick controls.



Armrest control

The additional discharge distance control in the armrest offers maximum operator comfort.



Stepless electric motor control

The hinged flap on the rear wall of discharge accelerator is adjusted infinitely via an electric motor.



The KRONE headers

- Convenient attachment and removal
- Maximum safety
- Very short set-up times
- Compact combination

The multi-coupler system of the BiG X allows operators to couple headers fast, easy and dependably from the seat, reducing changeover times when preparing for road travel or different crops. This way, more time is spent on productive work.



The perfect solution

The robust carrying frame features guide rollers at the top and a carrying bar at the bottom with locking pins (hydraulic as an option) which make attachment and removal easy and convenient and give accurate control to the header.



Very adaptable

Hydraulic cylinders on the sides of the pivoting bottom carrier allow the header to actively follow the ground contours. The hydraulic cylinders are made pressureless to give free pivoting.



Straightforward

The two guide rolls on the base machine trap the curved round steel bracket on the header. Attaching the header to the base machine is as simple as that.



A unique pivoting system

The header pivots laterally on the pipe bow that is trapped in the guide rollers. This type of attachment is easy and straightforward and makes for a large pivoting range.



Convenient for operators

The header is locked by means of bolts at the bottom beam of the carrier frame. These pin can be operated hydraulically as an option from the seat for convenient header attachment.

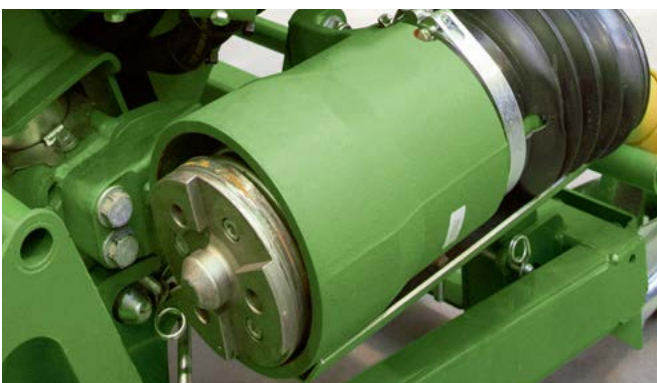

Automatic

The quick coupling, which can be spring-loaded as an option, provides for safe and easy connection of the header drive. The drive train is automatically locked in this process. The frictional connection copes with the highest loads.



KRONE EasyFlow 300 S · 380 S

The pick-up without cam track

- More power, quieter running, less wear
- Infinite speed adjustment from the driver's seat
- Automatic pick-up speed adjustment to the current driving speed
- Quick coupler and coupling hoop make for quick header attachment and perfect contouring
- Six rows of tines in W-arrangement

The camless EasyFlow 300 S and 380 S pick-ups by KRONE have neither deflection rolls nor cam tracks. Compared with conventional pick-ups, EasyFlow has up to 58% fewer moving parts, which makes it impressively smooth running, low-wear and therefore inexpensive in service and maintenance. EasyFlow operates 30% faster for cleaner gathering and increased productivity.

Convenience which lightens the workload

When the machine reverses, the auger conveyor and the crop press roller unit are raised automatically to give easy access to the intake system so foreign objects that were detected by the metal detector can be removed conveniently. When work is resumed, the holding-down clamp and the worm conveyor automatically return to their working position.



Two working widths

At a working width of 3.00 m or 3.80 m and six rows of tines arranged in W-shape, the camless KRONE pick-ups EasyFlow 300 S and 380 S are extremely efficient and leave no crops in the field. Depending on the swath width and your working speed, you can vary EasyFlow rpm steplessly from the driver's seat or have it adjusted automatically to the current forward speed without the operator having to interfere. Its curved round steel bracket gives the header the flexibility to pivot through a large angle and makes for easy attachment and removal.



W-shape

Six rows of double tines arranged in a W-shape allow for even crop collection while keeping the load and the power requirement to a minimum.

Not only does this pick-up gather the crop effectively but it also maintains a consistent flow in lumpy swaths for an excellent quality of chop.



With crop press roller unit

The EasyFlow has an adjustable large-volume crop press roller unit as a standard feature. This ensures a uniform flow of material into the machine also at high work rates.



Adapting all the time

Its stepless height adjustment function and adjustable spring-loaded suspension allows the crop press roller to roll smoothly and adapt easily to varying swath widths.



KRONE EasyFlow 300 S · 380 S



Rapid travel between fields

The height-adjustable guide wheels which follow up on the sides move hydraulically into transport position - simply upon a touch of button.



Excellent ground tracking

Depending on the working width, one or two rear cam follower rollers optimise ground tracking. The height of the cam follower rollers is adjustable.



High throughputs

The large 600 mm diameter feed auger performs impressively even in dense, over-long crops.

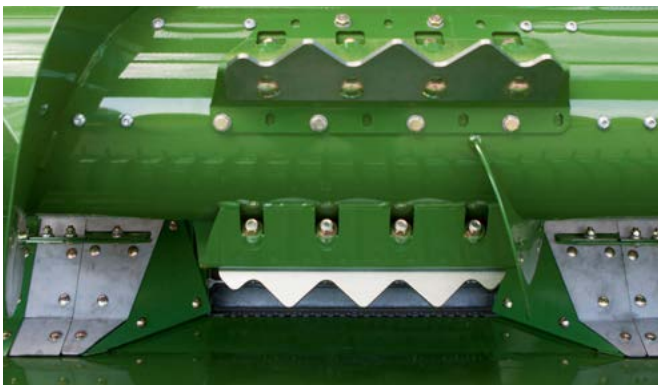

Hardox wear plates

Replaceable Hardox wear plates increase the lifetime of the trough in the intake area. Hardox is extremely durable and convinces also in the most demanding conditions.



Adjustable infeed sheets

The serrated infeed plates can be set to one of two positions to provide different levels of aggressiveness, giving you the flexibility to respond to all conditions.



Strong drives

The side drives for the pick-up and the auger conveyor are robust enough to handle even the toughest loads. They are fitted with automatic clutches for overload protection.



KRONE XDisc 620

- Direct cut headers with 6.20 m working width
- Heavy throughput, low power requirement
- KRONE EasyCut mower technology that is proven the world over
- KRONE **SafeCut**: unique protection for mower discs
- Powerful feed auger with replaceable HARDOX wear plates

Based on the well-proven KRONE EasyCut cutterbar technology, the XDisc direct cutting system allows the BiG X to cut and chop whole crop silage in one operation, which features SmartCut cutting performance and quality and SafeCut impact damage protection.

SafeCut – only by KRONE

As everybody knows, colliding discs may cause damage and involve costly repairs. KRONE SafeCut offers a maximum of protection and peace of mind. A unique technology protects the mowing discs from foreign objects. The XDisc comes with SafeCut as standard.



Safe as houses

If the system is suddenly overloaded, the impact is not directed to the spur wheels in the cutterbar, instead the roll pins in the sprocket drive shaft shear off. The pinion shaft continues spinning, jacking up the mowing disc in question and moving it out of the risk zone and the orbit of the neighbouring discs. As a result, SafeCut prevents damage to the spur wheels and the neighbouring discs. The roll pins are replaced within a few minutes, saving costs and minimizing downtime.



Mowing and chopping in one work step

As a specialist for whole crop silage, KRONE XDisc is highly versatile. XDisc stands for loss-free harvest and convinces with a clean cut. The huge 900 mm diameter auger makes the unit enormously powerful and has no trouble picking up very long and bulky material.



KRONE XDisc 620

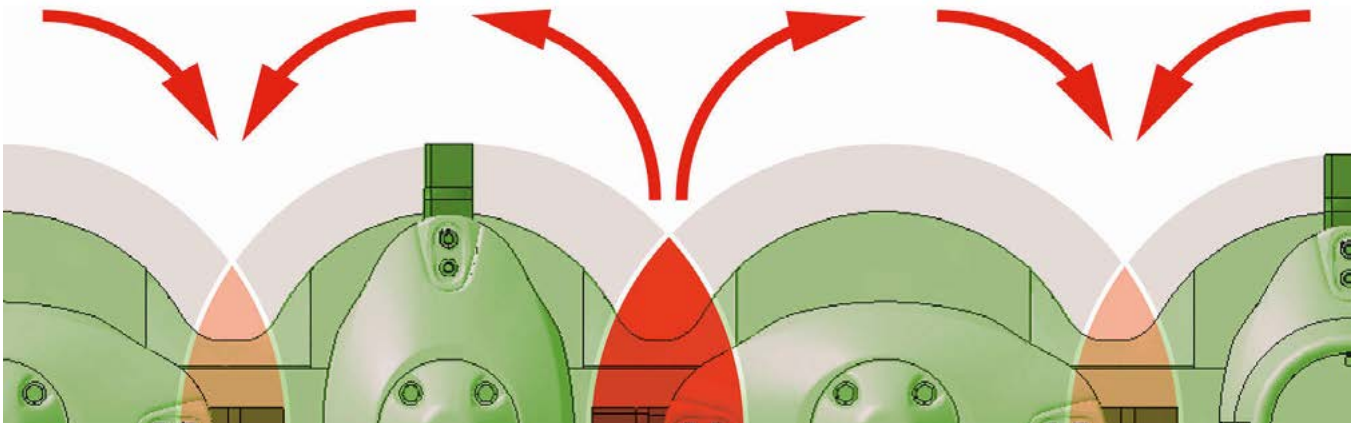

SmartCut for stripe-free cuts

With some mowing discs turning in pairs towards each other and others turning away from each other, it was necessary to redesign the degree of blade overlap to ensure cleanest swaths. For a stripeless swath, we have therefore increased blade overlaps on the cutter blades turning outwards between the discs turning away from each other. In addition, the blades turning to the rear are set further apart to encourage a smooth flow of large volumes of crop.



Changing blades in an instant

Quick-change blades are a must for many farmers and contractors, because this way they can replace blades quickly and easily on the site.



Powerful throughput

The powerful and massive 900 mm diameter feed auger works trouble-free even in dense and tall crops. It pivots freely and can be reversed. The auger flights have replaceable Hardox steel wear plates.



Clean cut

The hydraulic side knives (option) sever tangled crops effectively. This ensures low losses when harvesting a number of whole-crop silage mixtures.



Blockage-free work

An optional crop press roller is available for the XDisc header which optimises the crop flow into the machine when harvesting high-yielding and tall stands. The roller enjoys blockage-free work even in extreme conditions.



Safe road travel at up to 40 km/h

The XDisc is placed quickly and easily on the bespoke trailer. The integrated brake system ensures safe travelling.



Speed is of the essence

Fitting and removing the XDisc is quick and easy. With the rolls of the quick coupling, the harvester moves under the tubular frame of the XDisc. The spring-loaded quick coupling for the drive and the hydraulic locking device are available as options and increase the operator convenience.



KRONE EasyCollect

- Variable-row maize headers with 4.50 m to 9.00 m working widths
- Best quality of chop, fewer overlength fractions from linear crop feed
- Simple technology and low input power
- The central gearbox
- An extra running gear is available as an option for the two-piece EasyCollect model offering maximum road safety.

The variable-row EasyCollect header is a versatile unit that feeds the stalks lengthwise into the machine, which translates into an unsurpassed quality of chop, as a coarse chop is the last thing livestock farmers or biogas producers want. The unique collector principle cuts labour costs and has proved its worth time and again the world over.

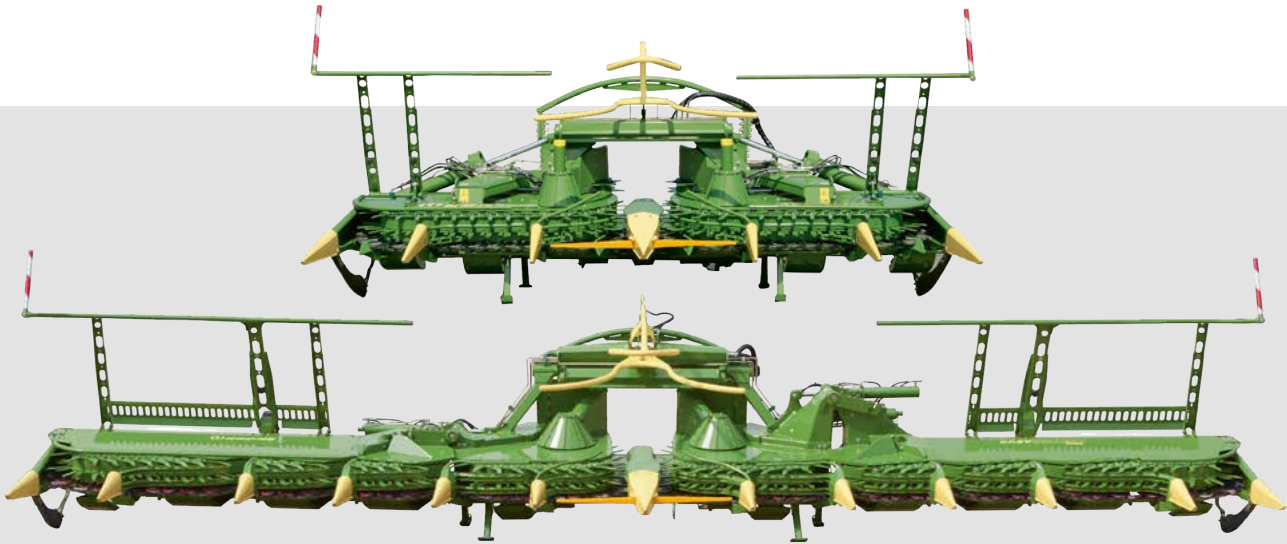

Unique – High-power & high-efficiency

With working widths between 4.50 m and 9.00 m, the BiG X 480, 530, 580 and 630 can be fitted with two- or three-piece variable-row headers for maize chopping. The endless collectors convey the cut plants to the middle, where they are fed lengthwise to the intake. This guaranteed top chop quality with few excess lengths.



Pulling the crop over the blades

Rigid multi-section blades and endlessly moving blades combine to sever the stalks with scissor-like cuts. The blades are self-sharpening and easy to replace.



Central drive

The drive power flows efficiently from the central gearbox down auto-coupling driveshafts to the folding collectors.



Straightforward and good

The two-piece maize headers stand out for their straightforward design and uncluttered build. Its narrow transport width, its slim design and excellent visibility translate into safe travel between fields.

Convenient for operators

An additional running gear is available for the two-piece maize headers which shifts weight to the front axle for safer and even more convenient road travel. The running gear is conveniently locked and unlocked from the cab.

Model	work width	No. of rows	Design
EasyCollect 450-2	4.5 m	6	2 sections
EasyCollect 600-2	6.0 m	8	2 sections
EasyCollect 600-3	6.0 m	8	3 sections
EasyCollect 750-2	7.5 m	10	2 sections
EasyCollect 750-3	7.5 m	10	3 sections
EasyCollect 900-3	9.0 m	12	3 sections
EasyCollect 1050-3	10.5 m	14	3 sections



KRONE EasyCollect



Simply ingenious

EasyCollect maize heads are built to a simple and modular design with endlessly moving collectors. This design leads to a much lighter weight, less maintenance and a long service life.



Clean gathering

EasyCollect can handle any situation. EasyCollect gathers the individual rows of maize firmly and feeds them to the middle of the header and into the chopper unit. It is this tidy and lengthwise feed that accounts for the outstanding quality of the chop.



Uniform stubble height

The ground tracers on either end of EasyCollect help maintain a uniform stubble height even in undulating terrain. They signal EasyCollect to follow the set working height in and across the direction of travel.



Optimum crop flow

The plant divider adjusts its height hydraulically to different stalk lengths, so the tubular bars at the top grab the stalks and pull them into the chopper unit.



Great stability and excellent tracking

When the autopilot is enabled, the sensor arms on the central tip of the maize header scan the distance between two maize rows. Then the BiG X is guided automatically along that row, which helps reduce operator fatigue.



Widest intake system

The EasyCollect intake channel dimensions match the width of the chopping drum and ensure maximum throughput and a top quality chop. The inline flow of the crop and the large intake combine to provide a steady and very tidy crop feed.



KRONE XCollect

The header that uses sickle discs.

- Available work widths are 6 m, 7.50 m and 9 m.
- Variable-row harvesting with rotating sickle discs
- Operates to the collector principle, splits the processes of cutting and feeding
- A smooth and soft cut eliminates vibrations and crop loss
- Operators adjust the cutting frequency infinitely variably to suit the prevailing harvest conditions

KRONE adds new XCollect headers to the long-standing and well-proven EasyCollect series. The XCollect headers split cutting and feeding into two separate processes, responding to customer demands to deal with diverse harvest conditions around the world.



Three working widths

The new XCollect header is available in three work widths:

- 600-3: 6 m (8 rows),
- 750-3: 7.50 m (10 rows) and
- 900-3: 9 m (12 rows).

The three-section headers work to the well-proven EasyCollect collector principle. The XCollect splits the action of cutting and feeding into two separate processes.

The XCollect models

Model	No. of rows	work width	Transport width	Design
600-3	8	6.00 m	3.00 m	3 sections
750-3	10	7.50 m	3.00 m	3 sections
900-3	12	9.00 m	3.29 m	3 sections

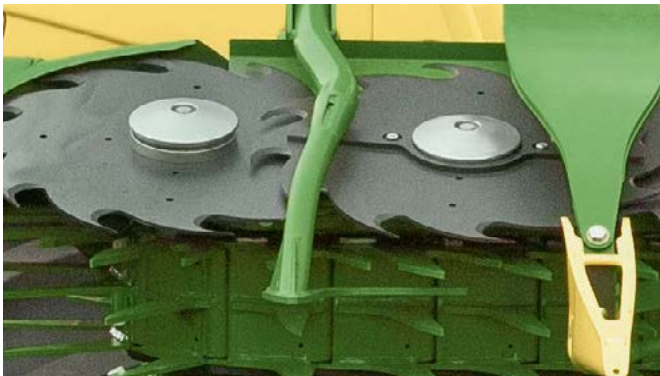

Cutting without counterblade

The stalks are cut by high-rpm sickle discs which rotate on massive bolts that connect them to the drive train. The cut stalks are then fed to the chopping drum by endless collectors above the discs which ensure a uniform lengthwise feed.



The central gearbox

Operators can select one of two speeds to adjust the cutting frequency to the individual crop and harvest conditions.



NEW

Convenient guard

The ingenious guard for the maize header is an option that forms an integral part of the header. It moves automatically in and out of position when the header folds into road or work position. The operator just presses a button. No need to leave the cab. A very convenient solution that reduces changeover times and boosts productivity.



KRONE XCollect

One header for all applications



Harvesting without losses

The sickle discs rotate on one plane, cutting the stalks without squeezing them. This technology minimizes vibration avoiding cob loss.

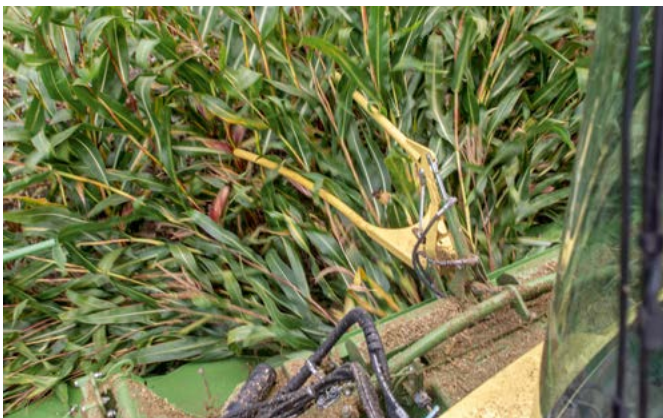

Everything under control

The well-proven collector feeds the stalks lengthwise to the chopping drum. It is this linear crop feed that enables precision chops and minimum overlengths. The variable collector speed is standard and ensures a consistently high quality of chop.



Fractured stubble

The high-speed sickle discs cut the stalks and defibrate the stubble for optimum breakdown.



Hovering over the ground

The header has three sensor skids, one in the middle and two out on the ends, for optimum contouring and clean cuts in undulating fields and for clean forage.



Protected driveline

Star ratchet clutches protect the sickle disc driveline from overload. Speed sensors scan the speeds of two discs and send potential overload information to the operator terminal. In addition to this, a friction lining on each disc offers additional protection.



Compact design

The wings on the three-piece XCollect headers easily fold up into their transport position. This design leads to a 3 m transport width for the XCollect 600-3 and 750-3 and a 3.29 m width for the XCollect 900-3 which have optimised hydraulic rams that lift and lower the wings even faster.



The engine

- 6-cylinder MTU in-line engine
- Final Tier 4 / Stage V compliant
- 490-653 hp continuous engine output
- High efficiency and quiet running

Cutting-edge technology from MTU takes engine power and economy to a new dimension. Common Rail injection and optimal torque synchronization translate into smooth running, low fuel consumption, high efficiency and minimal maintenance. The innovative KRONE power management guarantees highest efficiency with maximum throughput.

Model	Engine (Emission Stage V/Final Tier 4)		Engine displacement litres	Continuous engine output in kW/hp	Continuous X Power chopping output in kW/hp	Continuous Eco Power chopping output in kW/hp	Tank capacity Litres		
							Diesel	SCR	Silage additives
BiG X 480	MTU 6R 1300	R6	12.8	360/490*	338/460	–	1,220 (+230 option)	115	275 (option)
BiG X 530	MTU 6R 1300	R6	12.8	390/530*	368/500	–	1,220 (+230 option)	115	275 (option)
BiG X 580	MTU 6R 1500	R6	15.6	436/593**	408/555	338/460	1,220 (+230 option)	115	275 (option)
BiG X 630	MTU 6R 1500	R6	15.6	480/653**	452/615	338/460	1,220 (+230 option)	115	275 (option)

* Certified engine output to ECE R120 in kW/hp: 390/530** Certified engine output to ECE R120 in kW/hp: 480/653

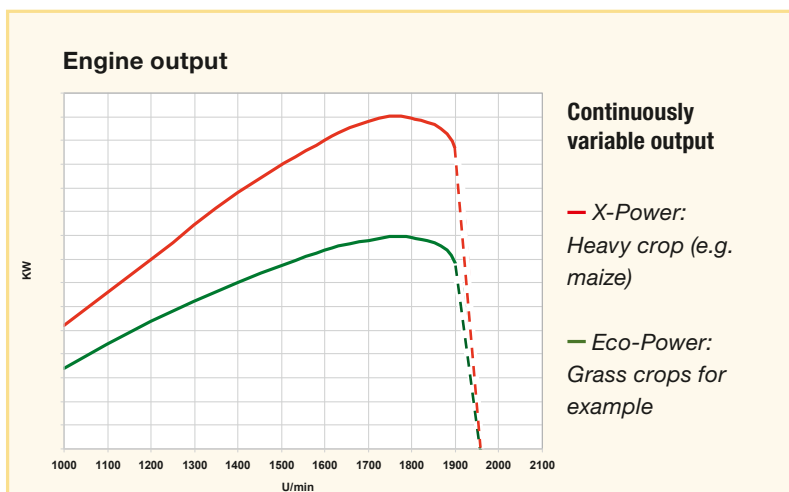

BiG X 580 and 630: PowerSplit

As an option, operators can control the engine output with a touch of a button. They can operate the machine in the fuel-efficient Eco-Power mode whenever the full power is not needed. Vice versa, when the full power is needed, you simply switch to X-Power mode. The machine does this automatically and continuously variably depending on the current conditions. Another useful feature is the optional engine speed management which boosts efficiencies and fuel economy.

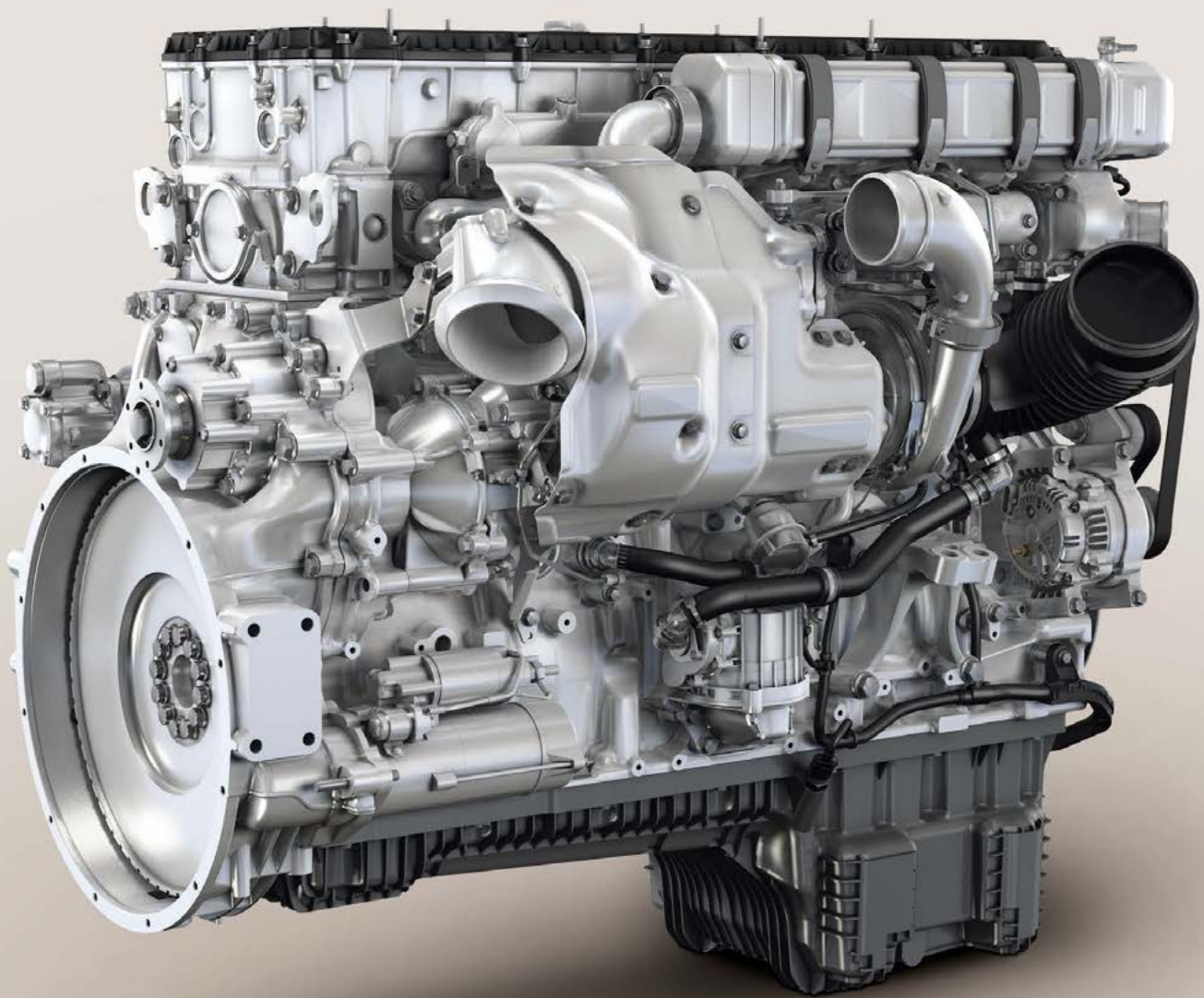

Transverse in-line engines

The engine is mounted sideways and far back for optimum weight distribution. The power flows from the engine directly to the components for crop flow - a setup that ensures maximum efficiency. The Common Rail injection makes the MTU in-line engines very efficient.



Cooling

With a rotating sieve and an active exhaust above the discharge accelerator, the cooling system provides cooling also in the presence of dust and crop residues in the air. The active exhaust is initiated with the start of the cutter drum, the sieve with the start of the engine.



The driveline

- Simple design
- An extra-strong poly V-belt transmits engine power to the crop assemblies
- Long service life
- Separate drive for the intake rollers and the headers:
Rollers and headers are reversible if the chopping drum suddenly stops
- Separate and dependable driveline to the drive pumps

The transversely mounted engine allows the drive pump, the chopping drum, the crop accelerator, the header and intake pumps to take the engine power directly off poly V-belts. No power take-off gear is required. All components for crop flow are activated via belt coupling.

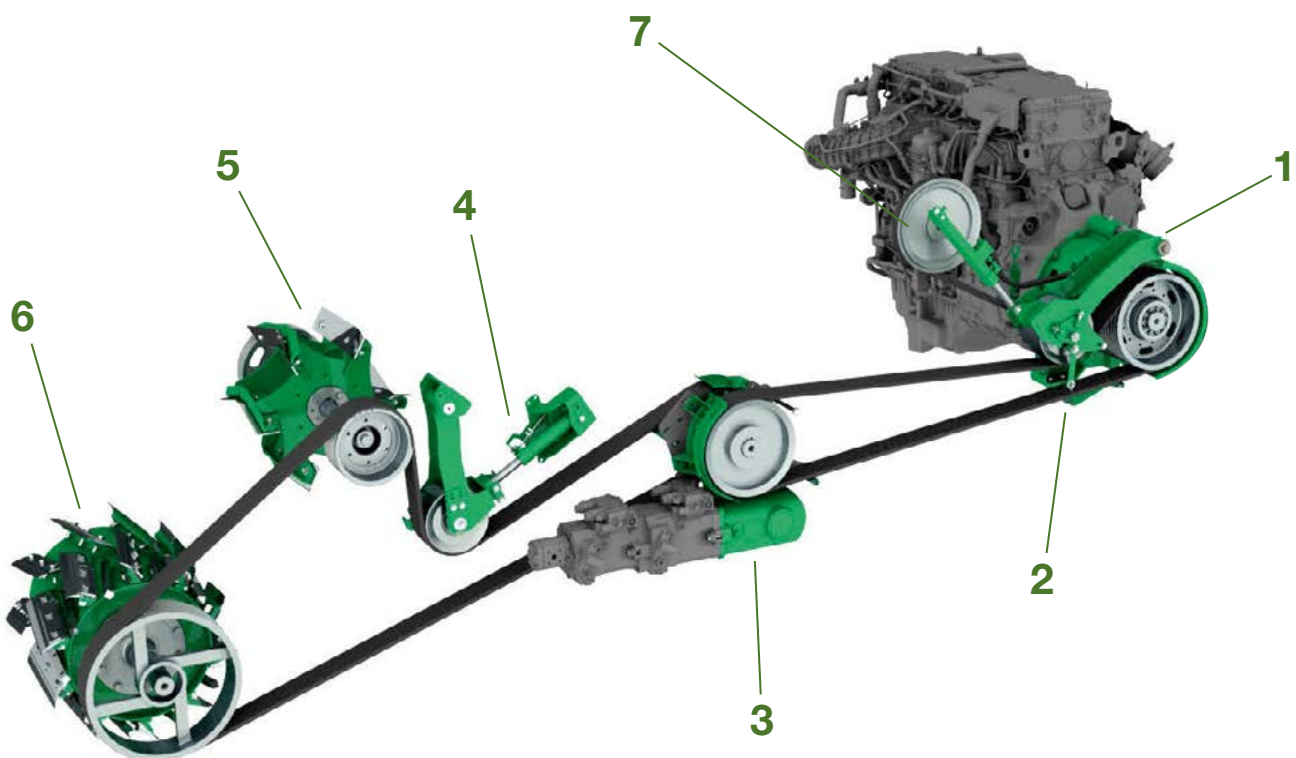

- 1 Drive pump
- 2 Belt tensioner for all components in the crop flow system
- 3 Hydraulic pumps for the intake system and header
- 4 Belt tensioner on the chopping drum and the discharge accelerator
- 5 Discharge accelerator
- 6 Chopping drum
- 7 Fan drive

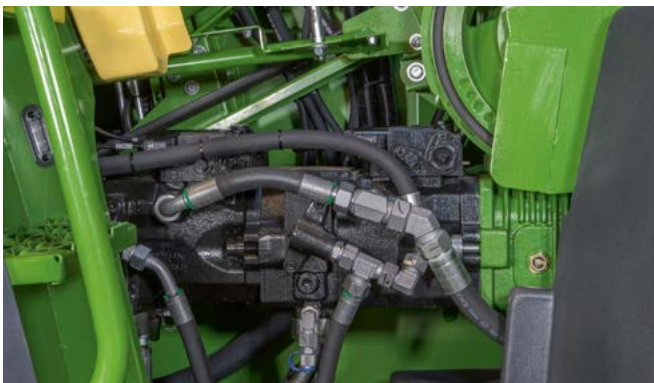

Clever

The header and intake system are driven by oil pumps. Flange mounted to a gearbox, these pumps are driven by a separated poly V-belt that transmits engine power directly to the pumps. This concept allows for infinite adjustment of header and intake speeds.



CVT transmission

Courtesy of a hydro pump that is flange-mounted on the main gearbox, BiG X changes its ground speed infinitely variably.



Drive of the components for crop flow

All components inside the crop flow are powered by two 6-groove poly V-belts. The hydraulic pumps that drive header and intake are arranged in the centre of the vehicle and can be switched on and off independent of the components for crop flow. This design allows for reversing of intake and header with the cutter drum at standstill. The brake of the chopping drum is integrated in the drive and offers maximum reliability.



The running gear

Innovative travelling

- Front-wheel drive is standard; four-wheel drive is an option
- Powerful wheel motors from Bosch-Rexroth
- Traction control with three travel modes
- Infinitely adjustable speed range of 0 to 40 km/h

The hydrostatic wheel motors offer greater productivity and a higher level of automation and operator convenience. At the same time, this type of power train reduces maintenance and frees valuable space to fit a bigger and more powerful chopping assembly and move this further to the rear of the machine.

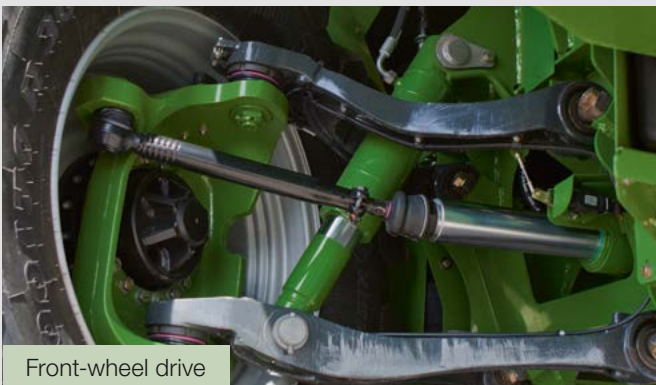

Front-wheel drive – four-wheel drive

BiG X 480, BiG X 530, BiG X 580 and BiG X 630 are available with hydraulic wheel motors on all four wheels as an option. Front wheel drive models have the wheel motors on the rear axle replaced by hubs. Both drives are dimensioned for driving speeds of up to 40 km/h.



An ideal system

The drive concept with hydraulic wheel motors provides for additional ground clearance, frees room for a larger diameter chopping drum and also leads to a more even weight distribution. The spring-loaded rear suspension ensures maximum driving comfort.



Infinitely variable drive concept

Courtesy of a hydro pump that is flange-mounted on the main gearbox, BiG X changes its ground speed infinitely variably. Thanks to standard independent wheel monitoring and traction control system, the BiG X has no trouble mastering difficult terrains.



Planetary gearbox

The wheels are driven by Bosch planetary gearboxes. Planetary gearboxes offer the advantage of distributing the load to several planetary wheels which are compact and enable high torques.



Traction control with three switchable travel modes

The operator decides which of the three travel modes to use. The mode that reduces wheel slip is usually selected when the focus is on protecting the sward. Maize foraging usually takes place in a mode that tolerates a higher wheel slip or even with traction control deactivated.



The running gear

Meeting the requirements of farmers and contractors

- Superb manoeuvrability from independent wheel suspension and wheel motors
- Sprung steering axle
- 3.00 m transport width depending on tyres
- Large choice of tyre options
- Height adjustable wheel motors
- Optional tracks minimize compaction

Travelling on narrow roads and lanes and manoeuvring in tight space are particular challenges for the operator. Therefore, BiG X features a compact build, hydrostatic drives and independent wheel suspension that make it agile enough to manage any corner and turn on tight headlands. With the matching tyres, its width remains under 3.00 m – perfect for narrow farm roads.

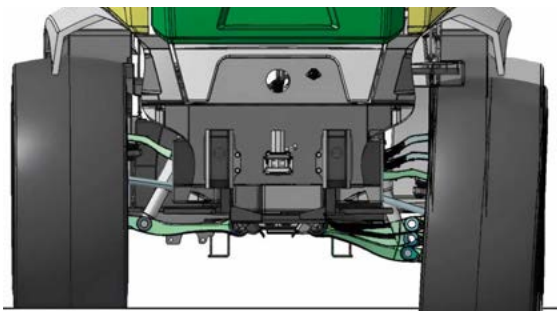

Great manoeuvrability from independent wheel suspension

The independent wheel suspension system offers plenty of room for steering so that even when clad with massive tyres, the BiG X remains a very nimble machine in undulating terrain. The spring-mounted independent suspension provides premium operator comfort.



A KRONE exclusive!

The wheel motors are mounted eccentrically on the front axle which allows you to fit small or large tyres and still retain the position of the pick-up, the intake system and chopping drum floor relative to the downstream crop flow. This detail warrants an optimum and consistent crop flow.



Superb manoeuvrability

The use of wheel motors allows the wheels to turn through 50° for tightest turns and perfect match-ups after headland turns with an 8-row maize header.



Vehicle width 3.00 m

With tyre sizes 710/70 R42 and 800/65 R32, the vehicle width is 3.00 m - for safe travelling on narrow roads.



Tracks

Tracks are available for the BiG X 480, 530, 580, 630 models so these can go into wet and boggy fields. The advantage of tracks over wheels is that they offer a larger footprint for reduced compaction in difficult conditions. The 76 cm tracks bring the total machine width to 3.00 m.



Tyres with a purpose

The BiG X 480, 530, 580 and 630 can be fitted with up to 900/60 R 42 tyres. The massive tyres guarantee maximum ground clearance, smallest ground pressure and ultimate operator comfort.



Kitted out perfectly

- LED lights are an option for best visibility at night
- Huge fuel capacity: up to 1450 litres of diesel with the optional additional tank
- Easy access for maintenance work

Long working days, sometimes even deep into the night, take a toll on the operator's endurance and concentration. This obviously requires excellent all-round visibility and full illumination at night, which is exactly what BiG X offers. The up to 1,450-litre fuel tanks hold enough diesel reduce the number of time-consuming top-ups and boost productivity Optimum access to all components ensures trouble-free service and maintenance.



Turns the night into day

16 headlights for optimum illumination make night work easier and safer. If you who want even more light you can opt for the LED lighting kit.



Full rear visibility

The low back section gives the operator excellent rear visibility – ideal for manoeuvring and turning on headlands.



Panoramic view

The hoods open wide and the rear mudguards give perfect access to all assemblies. LEDs are in place for easy service and maintenance even in poor light conditions.



Plenty of room

The BiG X 480, 530, 580 and 630 have plenty of room between the cooling system and the crop flow, offering good accessibility for cleaning and maintenance.

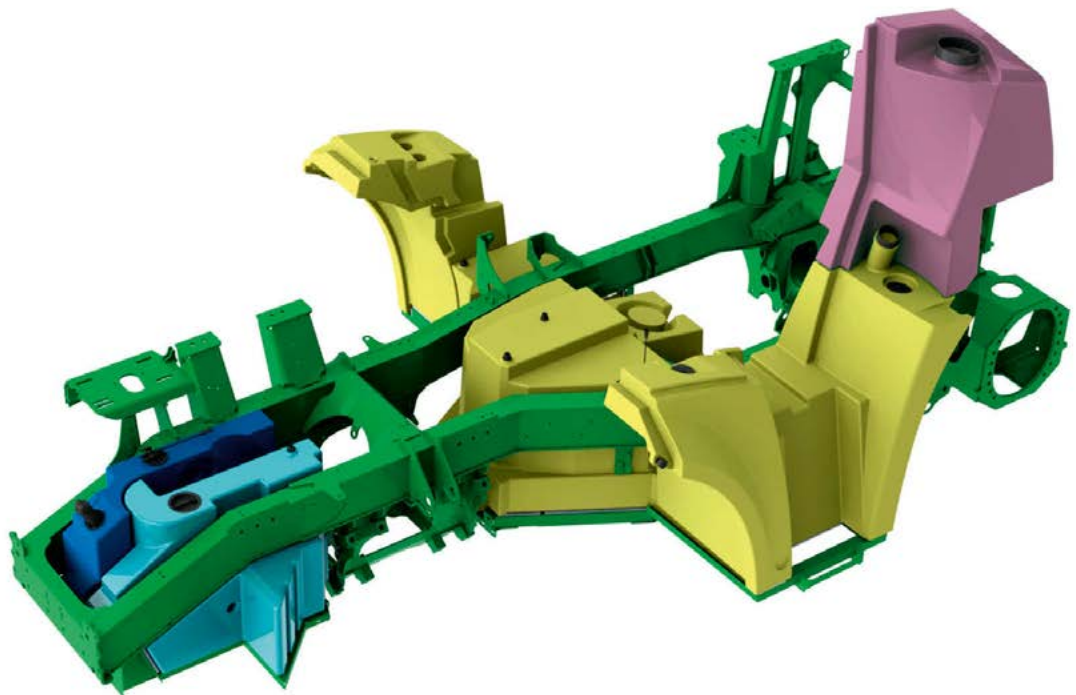

- Urea tank
- Additional diesel tank
- Diesel
- Silage additives

Up to 1,450 litres of diesel on board

The huge fuel tank provided as a standard holds up to 1,220 litres of diesel. An additional tank holds 115 litres of urea. The result are many hours of work without interruption for fuelling up. In addition to that, you can also opt for a 230l fuel tank and a 275l silage additive tank.



The cab

- Plenty of space and optimum climate control
- Large window screens offer perfect all-round visibility
- Maximum seating and operator comfort throughout a long working day
- User-friendly operator terminal with colour-display touch screen

New premium cab developed to the latest ergonomic insights Providing generous space and an extra seat, it offers a fully air-conditioned and absolutely functional working place, where the operator feels at home and has full command of all functions and controls.



Wider, quieter and brighter

The wide and slim posted cab offers plenty of space and best view of the headers with wide working widths. The double floor gives effective insulation from noise. 14 halogen head lights and work lights or 17 LED lights as an option provide perfect illumination in any situation and make your job easier in poor light conditions.



Clear view all-round

No matter the conditions – rain or dust –BiG X operators always enjoy a clear view thanks to three optional wipers on the front window, two on the side windows and one on the rear window. All wipers have spray nozzles for optimum cleaning.



Sun blinds

A roller blind on the front window and optional blinds on the rear and side windows protect against glare and bright sunlight.



The cockpit

The new Premium (Comfort) cab offers a most comfy working environment where you'll like to spend the day. The seat is ventilated and heated and has pneumatic suspension and all controls are in easy reach. The steering column offers three setting options that allow you adjust the tilt to your individual needs. The Comfort cab also has a cooled thermos box under the buddy seat. This working place is a pleasure to use.

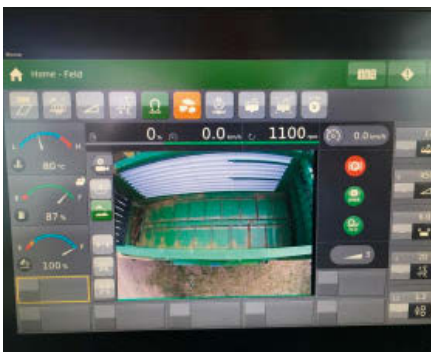

Keeping you informed

An 8" touch colour touch screen with USB and camera ports is standard specification on the BiG X (12" as an option). The terminal logs all major machine and harvest data and displays the camera feeds from the spout and rear end. Here you enter all kinds of settings including the infinitely variable chop length.



Ergonomic, convenient, good

The ergonomic shape of the multi-function lever with its user-friendly icons makes work easier and increases the operator comfort. Designed specifically for the BiG X, it fits the hand nicely. With more than 20 functions programmed to it, the lever not only controls driving speed and direction of travel but also the header and spout.



The KRONE Operator Assist Systems

- **AutoScan** enables operators to adapt the chop length relative to the current degree of maturity of the crop
- **ConstantPower** ensures minimum diesel consumption at maximum throughput
- **XtraPower** increases engine power on demand
- **EasyLoad** supports operators in filling the harvest fleet trailers to capacity
- **RockProtect** protects the forager from damage by stones

KRONE offers a range of different systems which help utilise our BiG X forage harvesters to their full potential and ease the strain on the operator. The electronic assist systems supply relevant data on the crop and provide reliable information in extremely difficult position.



AutoScan

The photo-optical sensor in the middle of the maize header records the degree of maturity of the maize plant and ensures that the chop length is adapted automatically. For better structure and less silage effluent in the silo, the chopping length for green maize is longer. For dry maize, however, a shorter chopping length is used for better compaction in the silo. AutoScan eases the strain on the operator and saves fuel because the plants are cut only as short as necessary, no longer as short as possible. In KRONE machines, AutoScan is the standard, not an expensive extra equipment.



ConstantPower

ConstantPower controls the harvester's driving speed in relation to the engine load. You press a button to select the engine load of your choice. The machine automatically adjusts the driving speed to the crops and to the volumes to be gathered. This feature eases the strain on the operator and provides for top throughput with very low diesel consumption. In combination with AutoScan, the system takes the overall quality of chop and machine performance to a whole new level.



NEW

XtraPower

The innovative XtraPower technology allows owners of a BiG X 480 / 580 to book more engine power (about 50 hp) from the new KRONE E-Solutions shops. Once this extra power is booked, it can be retrieved whenever it is necessary to boost throughputs temporarily. The machine must be in field mode and the chopping drum revolving to enable the feature. The XtraPower function is paused when no extra power is needed.



EasyLoad

The EasyLoad auto loading system in combination with a camera-based 3D image analysis system allows operators to fill any type of trailer that is running alongside the harvester. The system controls the "open/close spout" and the "rotate left/right functions" and allows operators to select one of several filling strategies. Monitoring all functions from the in-cab screen, operators are more at ease.



RockProtect

The six pre-compression rollers are powerful yet gentle. The optional RockProtect system provides intelligent protection from damage by stones. It fully automatically halts the pre-compression rollers within milliseconds after a stone is detected. The sensitivity of the RockProtect system is adjustable for added protection.



The KRONE Operator Assist Systems

- ISOBUS steering system for auto guidance
- **CropControl** for accurate yield metering
- **AgriNIR online sensors** measure moisture and nutrients on the move
- **AutoCalibrate** calibrates the BIG X yield metering system in the field
- Optional automatic counterblade adjustment from the cabin
- **KRONE SmartConnect** is a standard feature for convenient data management

The ISOBUS steering system guides the machine automatically along the preset way line without any operator interference. There are further systems available from KRONE that help operators measure, log and communicate the harvested crop weight per field and also measure moisture and nutrient levels.



ISOBUS steering system

As an option, every BiG X machine is ready to accept various ISOBUS guidance systems from different manufacturers. On the move, the operator activates autoguidance from the KRONE joystick, simply by pressing a button and then watches how the system guides BiG X down the bout. Automatic steering makes work easier for the operator and increases acreage output even with broad spreading, thereby increasing performance.



CropControl

The optional KRONE CropControl yield metering system measures the volume of crop harvested per field quickly and accurately at the touch of a button. With CropControl you document all yield data from all fields harvested.



Automatic counterblade adjustment

As an option it is possible to adjust the counterblade automatically and from the cab. Based on a knock sensor that measures the gap between the counterblade and the blades of the chopping drum and a rotary encoder that triggers two motors that adjust the counterblade, the system reduces operator stress as he or she can concentrate on the work at hand. At the same time, it is also possible to adjust the counterblade manually from the external control unit.



Metering moisture and nutrient levels

The optional AgriNIR online sensor supplies accurate data on moisture and nutrient levels on the move (DS, starch, crude protein, crude ash, crude fat, ADF, NDF). This data can be recorded in the machine terminal and assigned to the harvested area. The AgriNIR online sensor is easy to install on the BiG X spout where it is protected from damage by a cover.

SmartConnect

Another standard feature on the BiG X is the KRONE SmartConnect control box which provides GPS and Wi-Fi functionalities for the data management. All relevant data are recorded automatically and quickly sent from the harvester to the office PC – for straightforward and easy billing in less time.

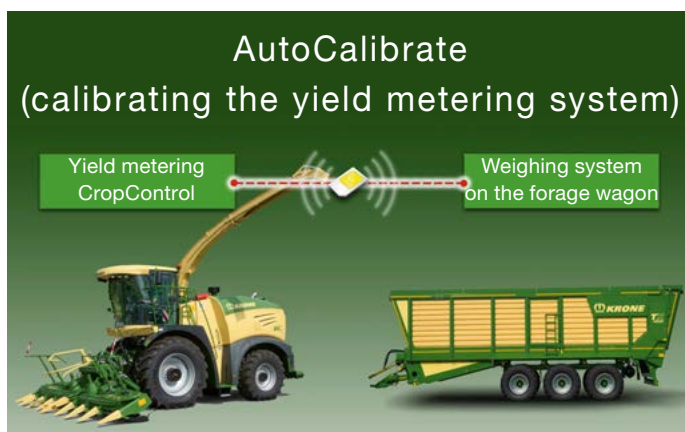

Convenient weighing

AutoCalibrate is the remote calibration tool for the BiG X's yield recording system. It operates via a weighing device installed on one of the trailers in the harvest fleet. Both the BiG X and the trailer are equipped with data loggers that communicate via a mobile network. Calibration takes place in real time as the 'calibrating machine' is being filled. AutoCalibrate is highly accurate and is the first system of its kind to eliminate the trip to the weighbridge.



Technical data

		BiG X 480	BiG X 530	BiG X 580	BiG X 630
Engine					
Model number		MTU 6R 1300	MTU 6R 1300	MTU 6R 1500	MTU 6R 1500
No. of cylinders		6	6	6	6
Engine capacity	Litres	12.8	12.8	15.6	15.6
Sustained engine power	kW/hp	360/490*	390/530*	436/593**	480/653**
Max. continuous chopping output X-Power	kW/hp	338/460	368/500	408/555	452/615
Max. continuous chopping output Eco Power	kW/hp	–	–	338/460	338/460
Tank content / volume additional tank diesel	Litres	1,220 / 230 optional			
SCR tank capacity	Litres	115			
Tank content silage additives	Litres	275 optional			
Ground drive					
Model		infinitely variable hydrostatic drive with wheel motors for up to 40km/h (25 mph)			
Speed in field mode	km/h	0-25			
Speed in road mode	km/h	0-40			
Selectable anti slip control		Standard			
4WD		Option			
Axles					
Steering angle on rear axle	Degrees	50			
Rear axle suspension		Hydraulic			
Drives					
Header		Infinitely variable			
Pre-compression rollers		Infinitely variable			
Pre-compression rollers					
Pre-compression roller throat volume		Funnel shaped			
Service position		Quick attach system (also with header attached)			
No. of rollers/metal detector/no. of magnet coils		6/series/6			
Metal detector - counterblade distance	(cm)	82 (2'8")			
Chop length adjustment		Infinitely variable from the cabin			
Chopping drum					
Drum width/diameter	(cm)	63 / 66 (2'0.8" / 2'2")			
Arrangement of blades		chevron style, at 11° to counterblade			
No. of blades		20, 28, 36, 40			
LOC range	mm	5-31/4-22/3-17/2.5-15 (0.2"-1.2"/0.2"-0.9"/0.1-0.7"/0.1-0.6")			
Cuts per minute		11,300/15,820/20,340/22,600			
Stepless drum floor adjustment / spring-loaded drum floor		Standard			
Grain conditioner					
OptiMaxx 250					
105/123 slanted teeth		Option/Option			
HD, Busa®CLAD***, slanted 105/123 teeth		Option/Option			
123/144 slanted teeth		Option/Option			
HD, Busa®CLAD***, slanted 123/144 teeth		Option/Option			
Speed differential	%	30 / option: 40 – 50			
Roller diameter / width / roll gap	mm	250/570 / 0.5-7 (10" / 22" / 0.02" - 0.3")			
Roller conditioners					
166 teeth: saw tooth profile		Option			
Roller diameter / width / roll gap	mm	250/570 / 0.5-7 (10" / 22" / 0.02" - 0.3")			
Distance control from the cab in combination with automatic lubrication		Standard			

* Certified engine output to ECE R120 in kW/hp: 390/530** Certified engine output to ECE R120 in kW/hp: 480/653

*** Busa®CLAD is a registered trademark of Gebrüder Busatis Gesellschaft m.b.H.

		BiG X 480	BiG X 530	BiG X 580	BiG X 630
Crop accelerator					
Rotor diameter/width/no. of paddles		560 / 595 (22" / 23") / 8			
Paddle arrangement		arranged chevron-style			
Speed	rpm	1,980			
Stepless adjustment of the backplate / spring-loaded backplate		Standard			
Spout					
Angle of rotation	Degrees	210°			
Unloading height	m	6.00 (19'8")			
Cross-section dimensions	(cm)	34x23 (1'1" x 9")			
Automatic mirror function/parking position		Standard			
Rotary drive system		Gearboxes			
Spout lined with wear plates throughout		Standard			
Service & maintenance					
Auto lubricator with compressor		Standard			
Self-diagnosing system via operator terminal		Standard			
Cab					
Air seat and buddy seat		Standard			
Comfort air seat and buddy seat		Option			
Automatic climate control with mobile cooling box		Standard			
Windscreen wipers on front and sides / Rear window wiper / 3 front window wipers		Standard / Option			
Dimensions					
Length/width* / height*	m	7.52-8.25/3.00-3.30/3.91-3.98 (24'8"-27'0.8"/9'10"-10'10"/12'10"-13'0.7")			
Base machine weight (without header)**	Approx. kg (lbs)	13,900 (30,644)	13,900 (30,644)	14,100 (31,085)	14,100 (31,085)
Weight distribution with EasyFlow 300 pick-up	F/R %	57/43			
Weight distribution with EasyCollect 750-3 (7.50m ww)	F/R %	60/40			
Tyres***					
Front axle	Standard****	680/85 R32			
	Option	710/75 R34			
	Option	710/70 R42			
	Option	800/65 R32			
	Option	800/70 R38			
	Option	900/60 R38			
	Option	900/60 R42			
Rear axle	Standard****	540/65 R30			
	Option	600/60-30			
	Option	600/70 R30			
	Option	710/60 R30			
Headers					
EasyFlow: Pick-up	m	3.00-3.80 (9'10"-12'6")			
EasyCollect variable row width header	m	4.50/6.00/7.50/9.00 (14'9"/19'8"/24'7"/29'6")			
EasyCollect variable row width header	m	6.00/7.50/9.00 (19'8"/24'7"/29'6")			
Autopilot and active ground contouring for EasyCollect		Option			

* Depending on tyre configuration

** Depending on level of specification

*** Does not combine with every tyre

**** Limited use depending on header used

1) Further options on request

All specifications, weights and dimensions do not necessarily comply with standard specifications and are therefore not binding. All product specifications are subject to change.

Maschinenfabrik Bernard KRONE

Perfect in every detail

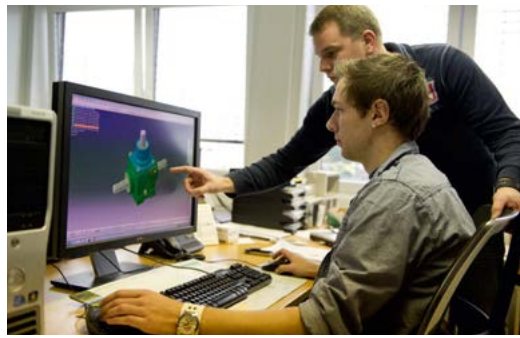

Innovative, proficient and close to our customers – these are the keywords that mark the philosophy of our family-owned company. As a forage specialist, KRONE manufactures disc mowers, tedders, rakes, forage wagons and silage trailers, round and square balers as well as the high-capacity and self-propelled BiG M mower conditioners and our BiG X forage harvesters. Quality made in Spelle – since 1906.

Your KRONE dealer



Maschinenfabrik Bernard KRONE GmbH & Co. KG

Heinrich-Krone-Straße 10
D-48480 Spelle

Phone: +49 (0) 5977 935-0
Fax: +49 (0) 5977 935-339

info.ldm@krone.de | www.krone.de